

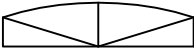









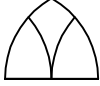
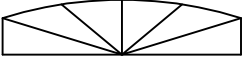
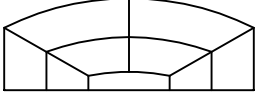



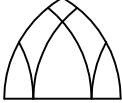

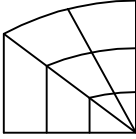
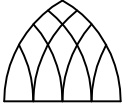
EXTENDED SEGMENTAL		EXT. PARTIAL SEG.	GOTHIC
 ES101	 ES111	 QS101	 G101
 ES102	 ES112	 QS102	
 ES103	 ES113	 QS103	 G102
 ES104	 ES114	 QS104	 G103
 ES105	 ES115		 G104
 ES106	 ES116		
 ES107	 ES117		
 ES108			
 ES109			
 ES110			

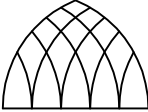
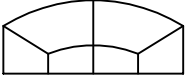
EXTENDED SEGMENTAL			EXT. PARTIAL SEG.
			
ES113	ES118	ES123	EPS105
			
ES114	ES119	ES124	EPS106
			
ES115	ES120	ES125	EPS107
			
ES116	ES121	ES126	EPS108
		GOTHIC 	GOTHIC 
ES117	ES122	EG101	EG102

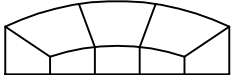
EXTENDED ELLIPTICAL

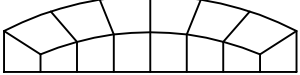
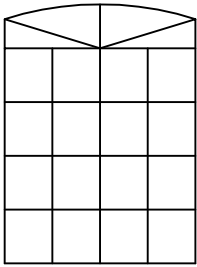
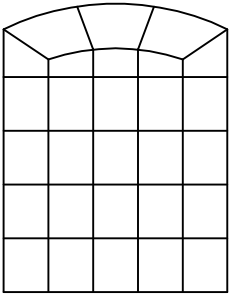
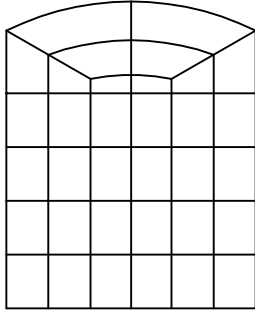
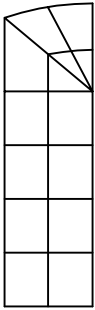
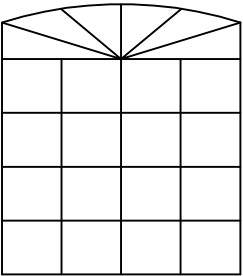
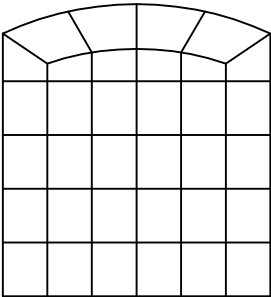
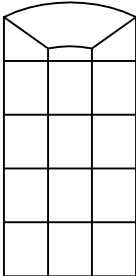
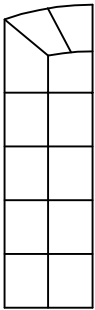
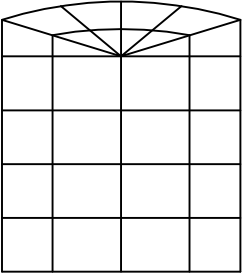
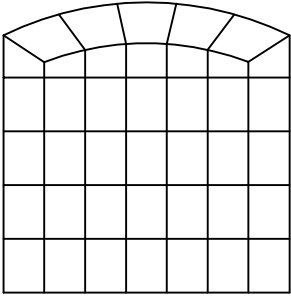
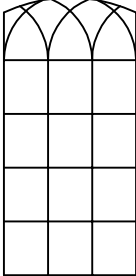
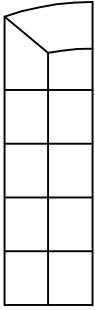
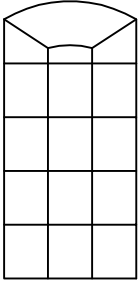
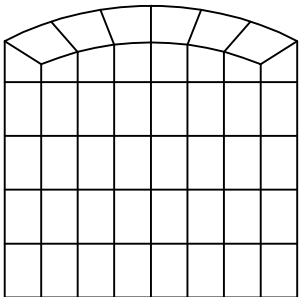
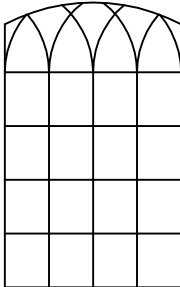
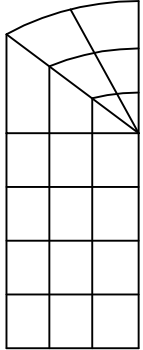
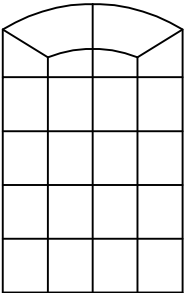
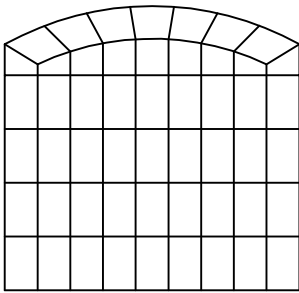
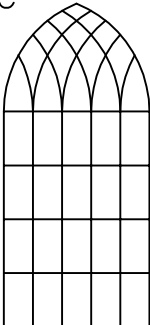
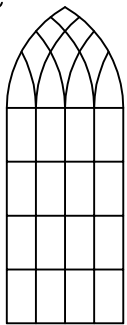
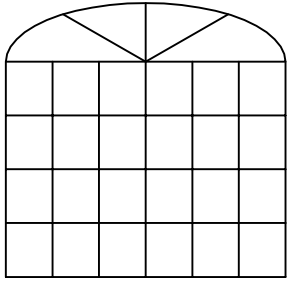

EE101

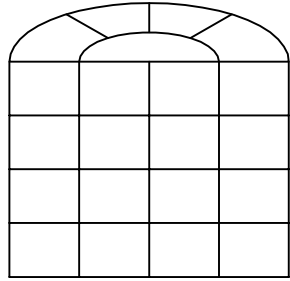

EE105

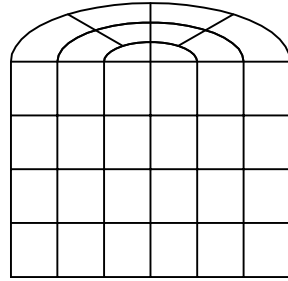

EE109

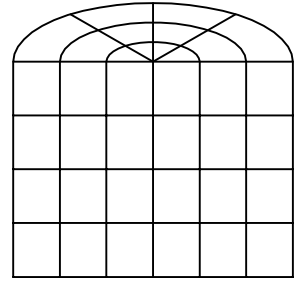

EE113

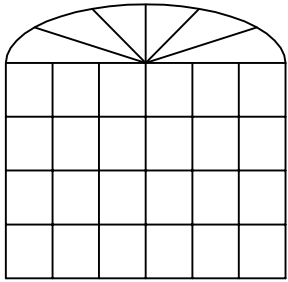

EE102

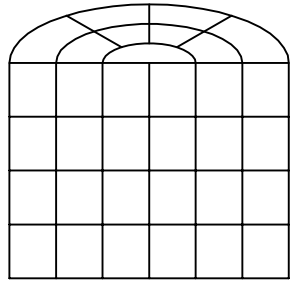

EE106

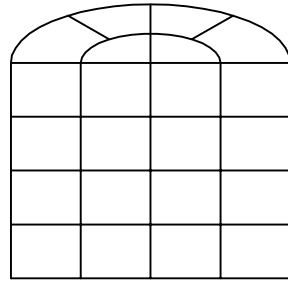

EE110

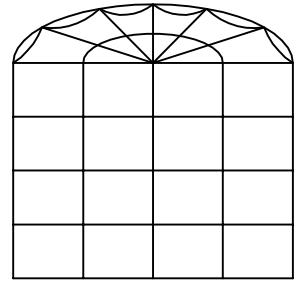

EE114

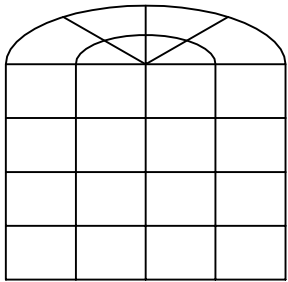

EE103

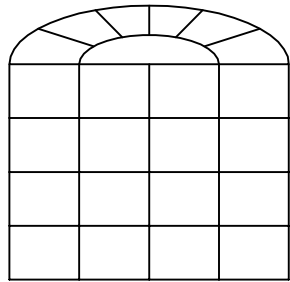

EE107

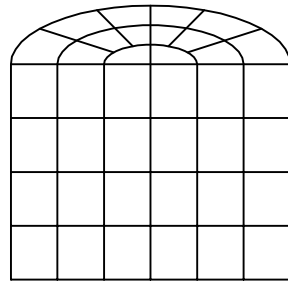

EE111

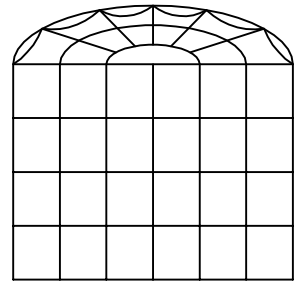

EE115

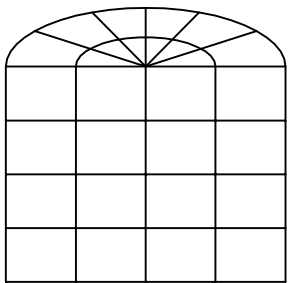

EE104

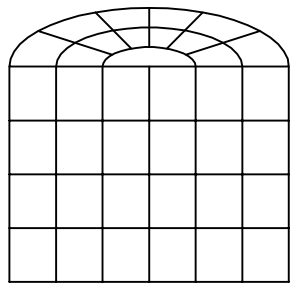



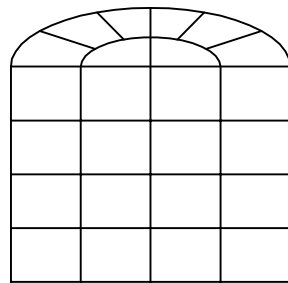



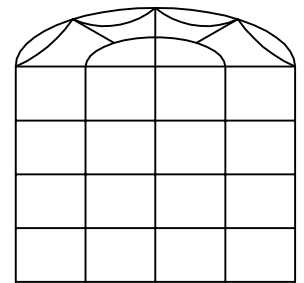

EE108

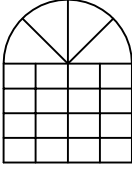
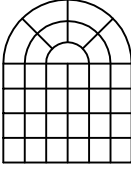
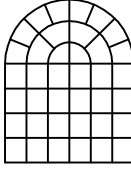

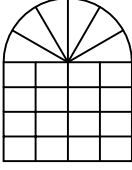
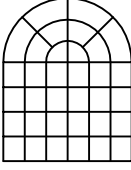
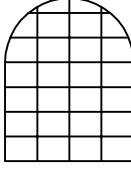

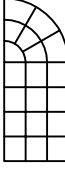
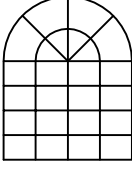
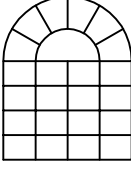
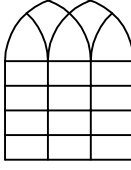
EE112

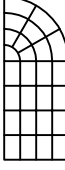
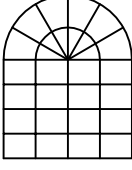
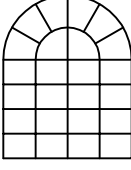
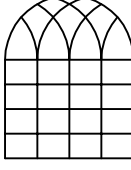
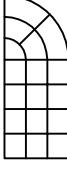

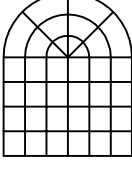
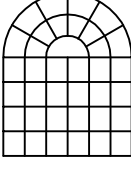
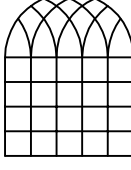
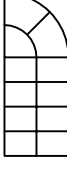
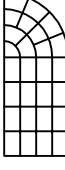
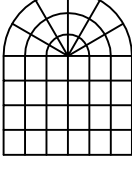
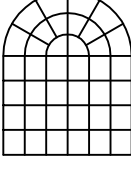
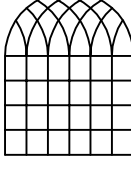
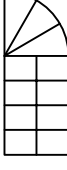
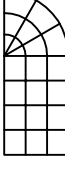
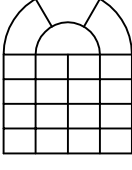
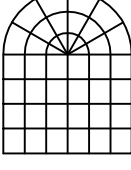
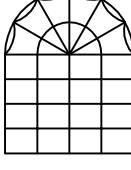
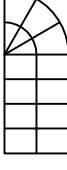
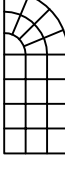
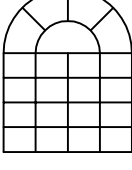
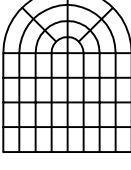
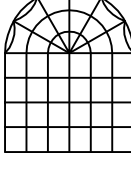
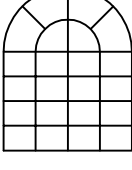
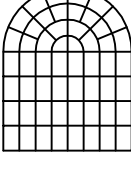

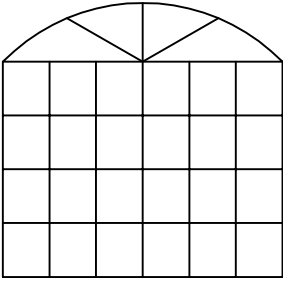
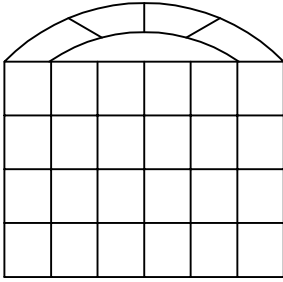
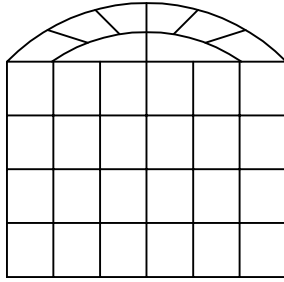
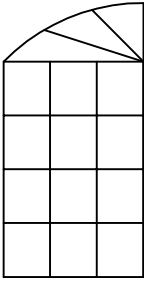
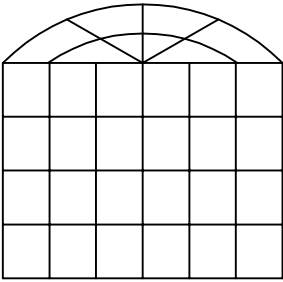
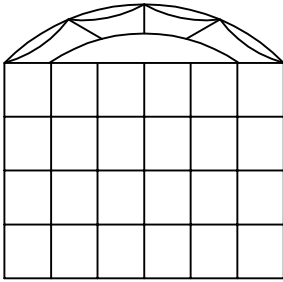
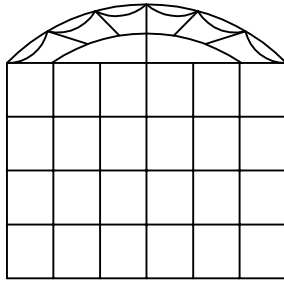
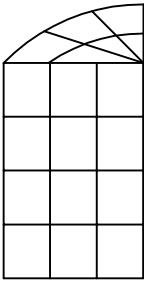
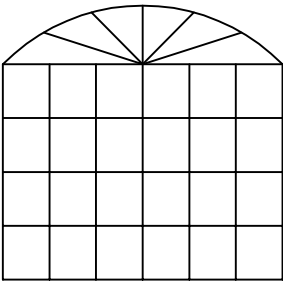
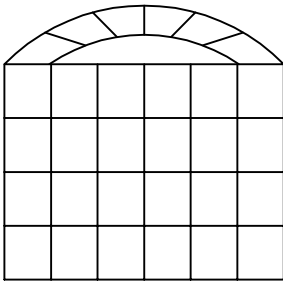
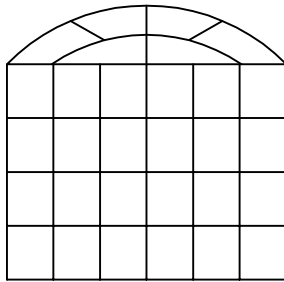
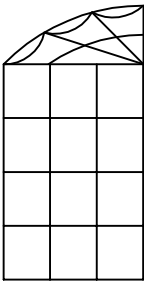
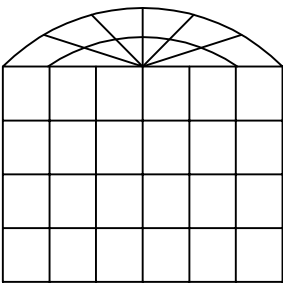
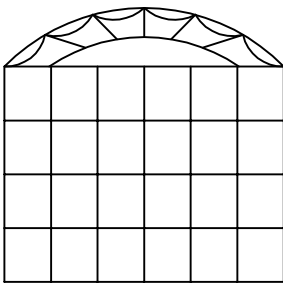
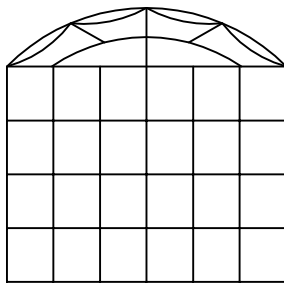
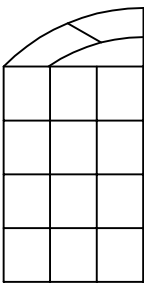

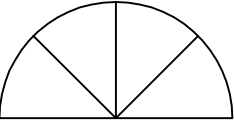
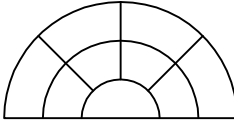
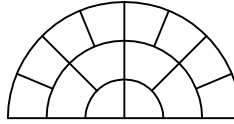
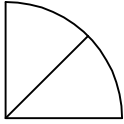
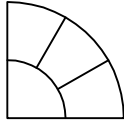
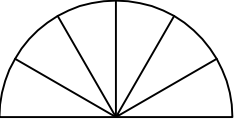
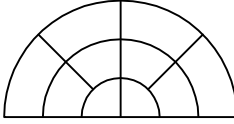
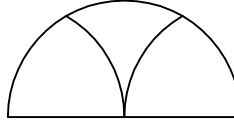
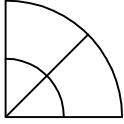
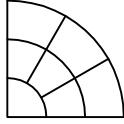
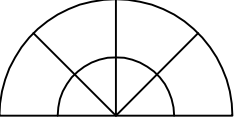
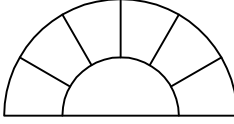
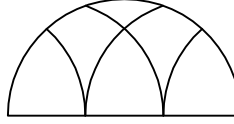
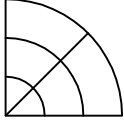
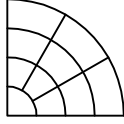
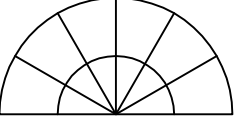
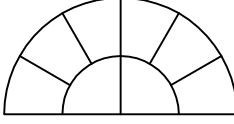
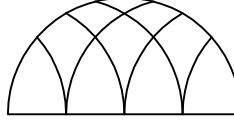
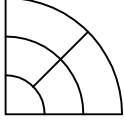
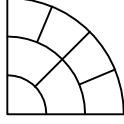
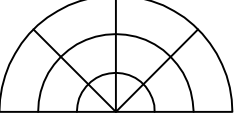
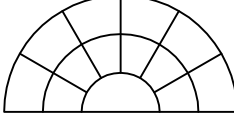
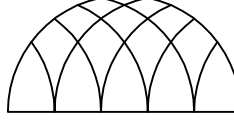
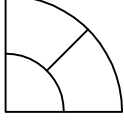
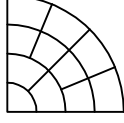
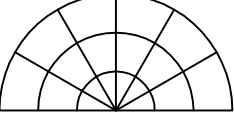
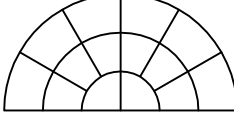
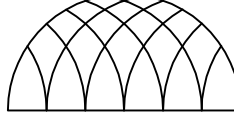
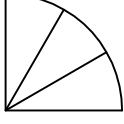
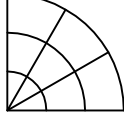
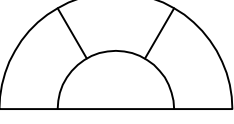
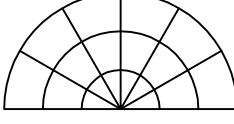
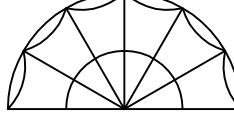
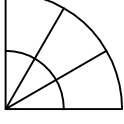
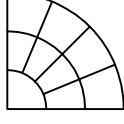
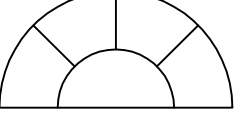
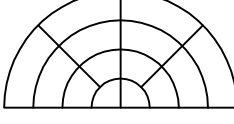
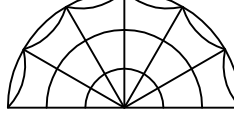
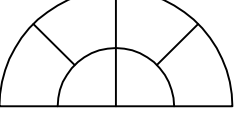



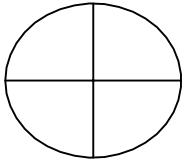
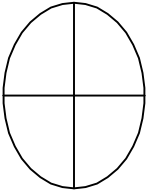
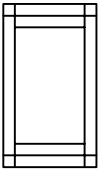
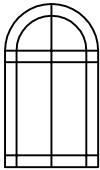
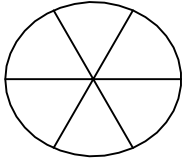
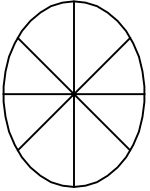

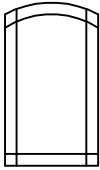
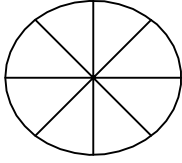
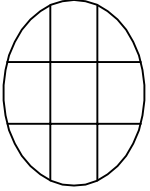

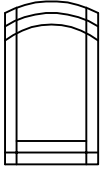
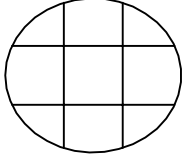
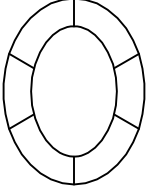
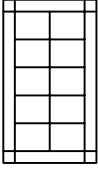
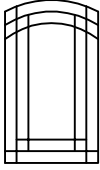
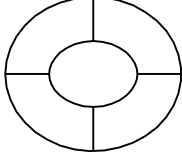
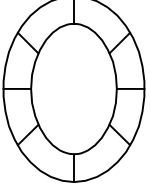
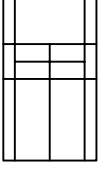
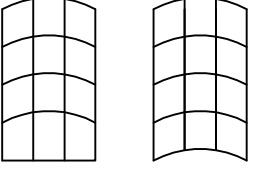
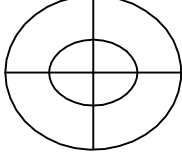
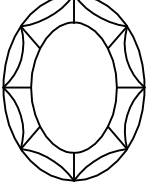
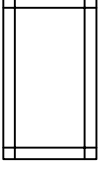
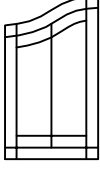
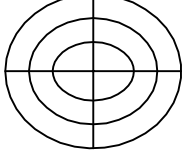
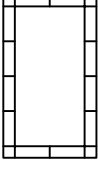
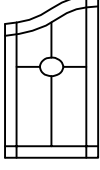
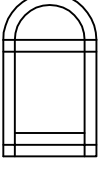

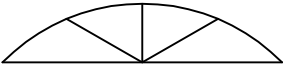
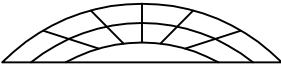
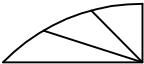
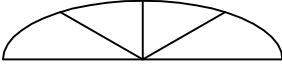
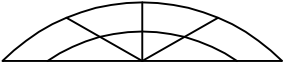
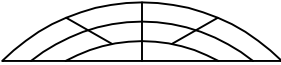
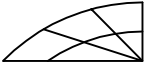
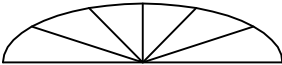
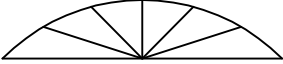
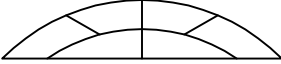
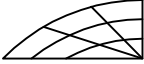
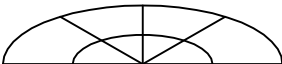

EE116

EXTENDED HALF ROUND			EXTENDED QUARTER ROUND	
 EHR101	 EHR110	 EHR119	 EQR101	 EQR108
 EHR102	 EHR111	 EHR120	 EQR102	 EQR109
 EHR103	 EHR112	 EHR121	 EQR103	 EQR110
 EHR104	 EHR113	 EHR122	 EQR104	 EQR111
 EHR105	 EHR114	 EHR123	 EQR105	 EQR112
 EHR106	 EHR115	 EHR124	 EQR106	 EQR113
 EHR107	 EHR116	 EHR125	 EQR107	 EQR114
 EHR108	 EHR117	 EHR126		
 EHR109	 EHR118			

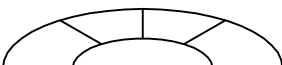
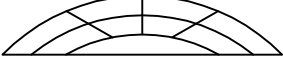
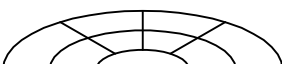
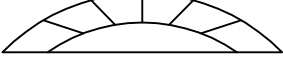
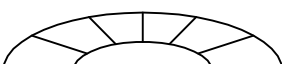
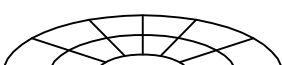
EXTENDED SEGMENTAL			EXT. PARTIAL SEG.
			
ES101	ES105	ES109	EPS101
			
ES102	ES106	ES110	EPS102
			
ES103	ES107	ES111	EPS103
			
ES104	ES108	ES112	EPS104

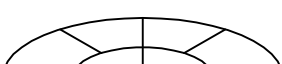
HALF ROUND			QUARTER ROUND	
 HR101	 HR110	 HR119	 QR01	 QR08
 HR102	 HR111	 HR120	 QR02	 QR09
 HR103	 HR112	 HR121	 QR03	 QR10
 HR104	 HR113	 HR122	 QR04	 QR11
 HR105	 HR114	 HR123	 QR05	 QR12
 HR106	 HR115	 HR124	 QR06	 QR13
 HR107	 HR116	 HR101	 QR07	 QR14
 HR108	 HR117	 HR101		
 HR109	 HR118			

 <p>R101</p>	 <p>OV101</p>		
 <p>R102</p>	 <p>OV102</p>		
 <p>R103</p>	 <p>OV103</p>		
 <p>R104</p>	 <p>OV104</p>		
 <p>R105</p>	 <p>OV105</p>		
 <p>R106</p>	 <p>OV106</p>		
 <p>R107</p>			
			

SEGMENTAL			ELLIPTICAL
 S101	 S108	 QS101	 E101
 S102	 S109	 QS102	 E102
 S103	 S110	 QS103	 E103
 S104	 S111	 QS104	 E104
 S105	 S112		 E105
 S106			 E106
 S107			 E107
			 E108
			 E109
			 E110
			 E111
			 E112
			 E113



Half Round



Quarter Round



Segmental



Partial Segmental



Elliptical



Gothic

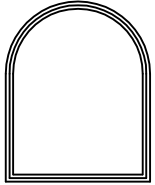

Extended Half Round

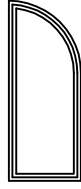

Extended Quarter Round

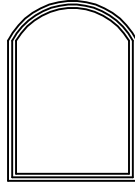

Extended Segmental

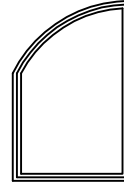

Extended Partial Segmental

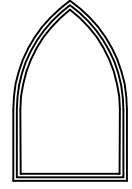

Extended Gothic

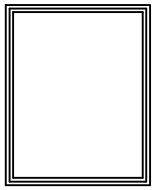

Rectangle



Right Triangle



Isosceles Triangle

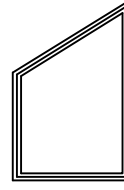

Trapezoid

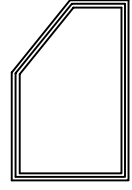

Clip Corner

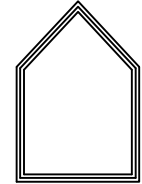

Double Clip Corner

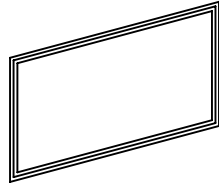

Parallelogram

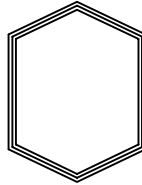

Hexagon

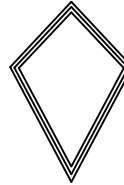

Diamond

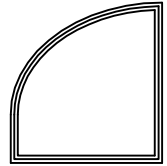

Extended Partial Elliptical

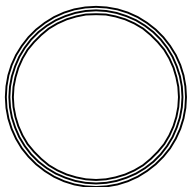

Circle

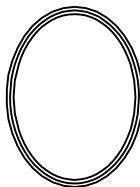

Oval

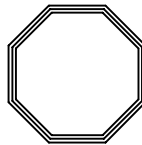

Octagon

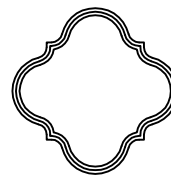

Quatrefoil

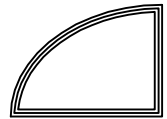

Partial Elliptical

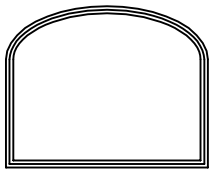

Extended Elliptical

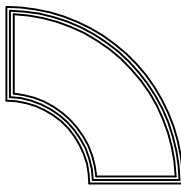

Quarter Arch

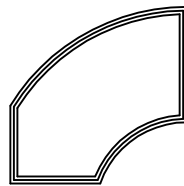

Partial Extended Arch

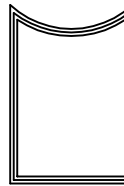

Extended Reverse Segmental

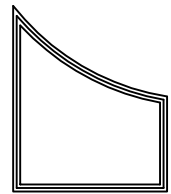

Extended Reverse Partial Segmental

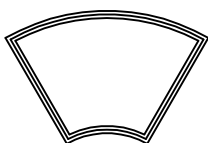

Partial Arch

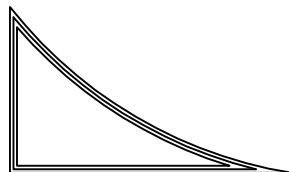

Reverse Partial Segmental

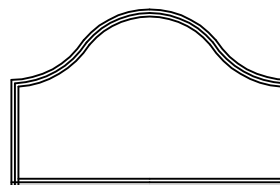

Extended Bell Curve



Bell Curve